



00-Current, Chevy Suburban/GMC Yukon XL IN277 12/15/04

NOTE: USE FACTORY HOLES ONLY

INSTALLATION PARTS LIST:	QTY.	DESCRIPTION
	2	RUNNING BOARD 1 DRIVER & 1 PASSENGER
	4	STONE GUARD 2 LEFT & 2 RIGHT
	8	3/8"x1 SELF TAPPING SCREW
	12	#14x3/4" TEK SCREW
	8	1/4"x5/8" SQUARE HEAD SCREW
	8	1/4"-20 HEX NUT
	4	8mm x 25mm Bolts
	4	5/16" Lock Washer
	4	HORIZONTAL BRACKET, SUPPORT, 3124F
	16	5/16"x 3/4" BOLT
	16	5/16"-18 HEX WASHER HEAD NUT
	4	FLAT BRACKET, FL102
	4	BENT TAB ASO2
	4	8mm x 25mm Bolts
	4	5/16" Lock Washer

TOOLS REQUIRED: 5/16" DRILL • 1/2" HEX SOCKET • 1/2" WRENCH • 5/16" NUT DRIVER • 3/8" NUT DRIVER

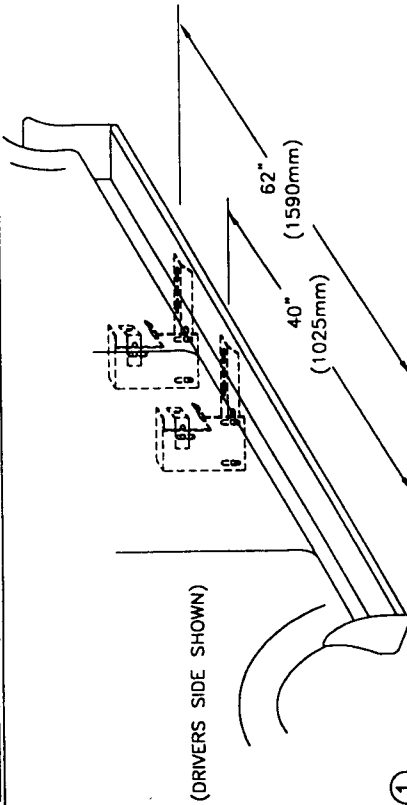

①

MEASURE FROM FRONT WHEEL WELL TO BRACKET LOCATIONS. MARK THIS DIMENSION ON THE PINCH WELD
NOTE: FACTORY HOLES WILL BE CLOSE TO THESE MEASUREMENTS—USE FACTORY HOLES ONLY

③ BRACKET ASSEMBLY MOUNT TO BODY

ON PASSENGER SIDE WITH AIR AND HEAT LINES. WRAP ASO2 ANGLE STRAP WITH FOAM TAPE SO THE LINES ARE PROTECTED. PLACE FOAM TAPE AT THE TOP OF ALL FLAT BRACKETS. ATTACH THE BRACKET ASSEMBLY TO THE FACTORY 8mm HOLES. DO NOT TIGHTEN YET. BOLT THE FLAT BRACKET TO THE FACTORY HOLES IN THE PINCH WELD. TIGHTEN ALL SCREWS EXCEPT TO HORIZONTAL BRACKET. NOTE: TOP OF THE FLAT PLATE MUST HIT ROCKER PANEL.

②

BRACKET ASSEMBLY ASSEMBLE WITH 5/16" BOLTS

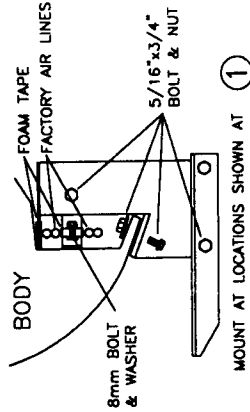
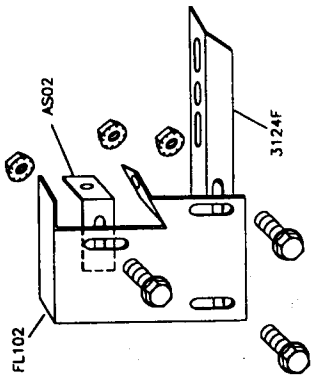

MOUNT AT LOCATIONS SHOWN AT ①

⑤ BEND STONE GUARD BY HAND AND KNEE TO FIT THE WHEEL WELL BEFORE INSTALLING TO RUNNING BOARD

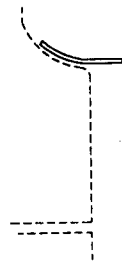

INSTALL STONE GUARD TO OTHER END OF BOARD

⑧

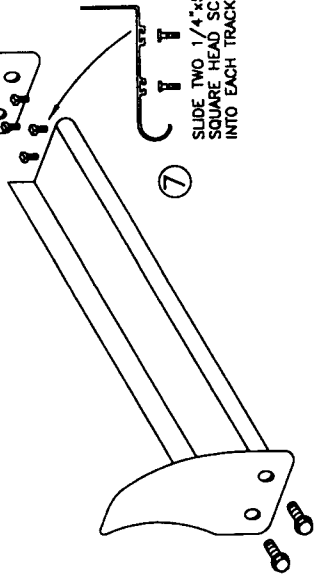

⑥

FASTEN FRONT STONE GUARD TO BOARD WITH 3/8" SELF TAPPING BOLT. BEND STONE GUARD BY HAND AND KNEE TO FIT THE WHEEL WELL

⑦ SLIDE TWO 1/4"x5/8" SQUARE HEAD SCREW INTO EACH TRACK.

NOTE: BE SURE THAT 1/4" BOLTS ARE PLACED INTO THE BRACKET STEP SUPPORT

⑨

HOLD BOARD IN PLACE WITH THE REAR RESTING ON THE BACK BRACKET

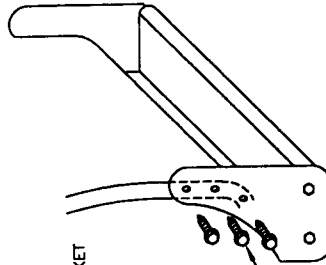

⑩

SCREW THROUGH STONE GUARD INTO FENDERWELL LIP USING #14 BY 3/4 SELF DRILLING SCREWS. MAKE SURE YOU DRILL INTO METAL

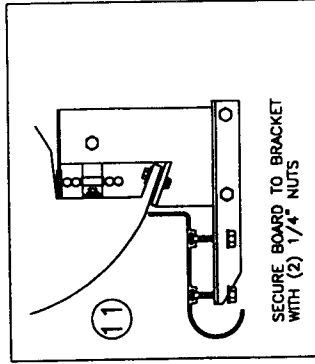

⑪ SECURE BOARD TO BRACKET WITH (2) 1/4" NUTS

3 PLACES AT EACH STONE GUARD

⑫

WITH BOARD LEVEL TIGHTEN ALL LOOSE BOLTS

⑬

REPEAT FOR OTHER SIDE

IN277 12/15/04